

Vissari Rangehoods

SILENT INNOVATION

VISSARI ONBOARD PRODUCT
& INSTALLATION USER GUIDE

MODEL
VISC900



CONTENTS

- 03** Welcome
- 04** Safety
- 05** Pre-Installation
- 06** Installation
- 08** Operation
- 09** Cleaning
- 10** Condensation
- 11** Warranty

WELCOME

Thank you for purchasing a Vissari Rangehood.

Please read through this guide before installation and use.
Please retain your proof of purchase to aid in any warranty claim.



SAFETY

There shall be adequate ventilation in the room when the rangehood is in operation.

Do not flambé under the rangehood. This will damage the rangehood and it will not be covered by warranty.

Do not ignite burners that give off intense, uncontrolled flames beneath the rangehood.

Make sure that no flames emerge from the sides of pans.

The rangehood ducting system must not be discharged into a flue that is used for any other duct and or extract system.

Prior to cleaning or any maintenance, disconnect the rangehood from the power supply.

Do not use the rangehood without the filters installed.

Keep the filters clean, clean frequently.

Turn the rangehood fan on 5-10 minutes before starting to cook.

Turn the rangehood fan off 10-15 minutes after you finish cooking.

Range hoods and other cooking fume extractors may adversely affect the safe operation of appliances burning gas or other fuels (including those in other rooms) due to back flow of combustion gases. These gases can potentially result in carbon monoxide poisoning. After installation of a range hood or other cooking fume extractor, the operation of flued gas appliances should be tested by a competent person to ensure that back flow of combustion gases does not occur.

PRE-INSTALLATION

Please check your Vissari rangehood for any damages prior to installation, do not install any damaged rangehood

Please contact Vissari Rangehoods in the event of a damaged rangehood at installation time.

Vissari rangehoods must be installed to the specifications below, we recommend using Vissari ducting and ducting components.

Vissari is not responsible for any substandard installation that is carried out differently to the installation guidelines below.

Please contact Vissari for a list of recommended trained installers.

Please read the entire set of instructions before installing or using this appliance.

Heavy lifting – Please take care when lifting and installing the Rangehood to prevent any personal injury.

Suitable solid in wall fixings will be required to install this rangehood, the rangehood must not be installed directly to gib board, there must be solid timber fixing behind the gib board at the installation screw fixing points.

Always switch the power off prior to installation.

All electrical work must be carried out in accordance with local building codes and regulations.

A power outlet can either be on the wall, behind the chimney or in the ceiling. The socket must be accessible, or have an accessible isolating switch, to enable the end user to isolate the rangehood from the power for the purpose of internal cleaning or maintenance.

If the supply cord of the rangehood is damaged, it must only be replaced by Vissari, its service agent or similarly qualified person.

Ducting accessories are not supplied. All ducting must comply with local requirements and building codes.

All ducting roof penetrations must be carried out in accordance with local building codes and regulations.

Exhaust air must not be discharged into an existing flue or any combined flue that is used for exhausting fumes from gas appliances or bathrooms.

This appliance is not intended for use by persons (including children) with reduced physical, sensory, or mental capabilities, or lack of experience and knowledge, unless they have been given supervision or instruction concerning the use of the appliance by a person responsible for their safety.

Remove all packaging, including protective wrappings, before use.

INSTALLATION

Required equipment for installation

We recommend Vissari rangehoods are installed by a recommended installation tradesperson.

Variety of Battery Drill Tools

Variety of Hand Tools

Variety of Drill Bits and Hole Saws

Ladders / Drop Sheets

Installation

Do not install this appliance if you find it damaged.

If this Vissari rangehood is installed damaged, Vissari will not be responsible for any costs associated with the repair, replacement, removal or re installation of the Vissari rangehood.

Vissari recommends the rangehood be installed by a qualified rangehood installer.

Do not modify the rangehood in any way, Modification of any kind will void the warranty.

Ensure the rangehood is installed in accordance with all local council laws and regulations.

Recommended & Optimum Installation height is 750mm from benchtop to underside of the rangehood.

Minimum Installation height above an electric hob is 650mm and a gas hob is 750mm.

Unwrap the rangehood and inspect for damage, plug in, and test the power and operation while planning the installation.

Mark the centre line of the hob below on to the installation wall above and mark a horizontal finished installation height line (Optimum 750mm).

Relay the rangehoods main body hanging points on to the installation wall.

Screw and fix the rangehoods main body to the wall, ensure all screws are fixed into timber framework behind the gib wall lining.

Cut (depending on the model) a 160mm or 210mm hole for the ducting in the ceiling.

Draw the ducting down from ceiling and connect to the rangehood outlet with tape and cable ties.

Plug in the rangehood and test.

Install the two flue covers.

Clean and commission rangehood.

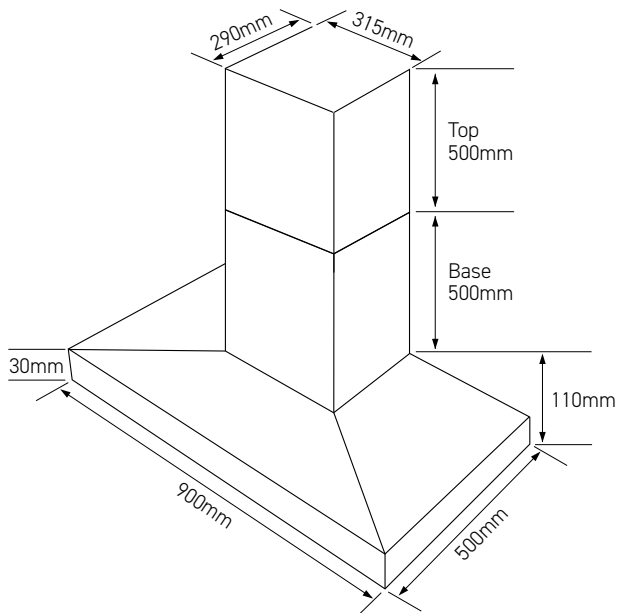

Ducting

Vissari onboard rangehoods must be installed with high quality 150mm semi rigid ducting to achieve optimum extraction and performance noise levels.

This requires a 160mm round hole cut in the ceiling or wall.

Do not reduce ducting size.

Avoid sharp bends in the ducting route.

A short direct ducting route is optimum, avoid long ducting routes with many bends.

Avoid using flexible ducting.

Flexible ducting should only be installed as a last option, if installed ensure that it is a short direct route to the termination point and extended tort, so no slack duct occurs.

All ducting materials and fittings are available from Vissari.



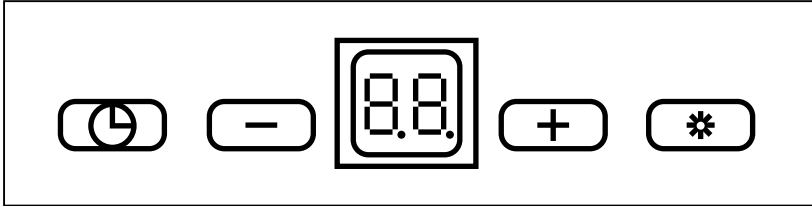

OPERATION

Turn the rangehood fan on 5-10 minutes before starting to cook.
Turn the rangehood fan off 10-15 minutes after you finish cooking.

Control Panel



Press + to switch on the fan. The timer will only operate when the fan is switched on.

-  Press - to decrease the fan speed
-  Press + to increase the fan speed
-  To switch on or off the lights
-  Up to 15 minutes timer setting and fully adjustable. When you press the timer button the digital display will change to "00" timer mode. You can adjust your timer mode (up to 15 minutes) by pressing "-" or "+"

Replacing the Light Bulb

DANGER



Always switch off and disconnect power before replacing the light.
Failure to do so may cause serious injury. Please be aware that the light bulb will retain heat for a short period of time after being switched off.

Step 1

Remove the filters from the rangehood.

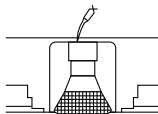

Step 2

Gently turn light bulb anti-clockwise, pull the light bulb down and remove it from the light holder.

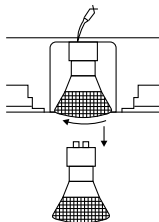

Step 3

Insert a new bulb by lining up the pins of the light bulb with the larger holes inside the light holder. Once the pins are in place, turn clockwise to secure the light bulb.

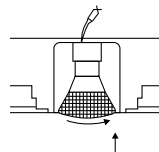

CLEANING

Interior

Clean the interior of the rangehood with neutral detergent and a damp cloth.

Exterior

We recommend using spray on 'Steel Kleen' applied to a soft cloth and then gently applied to the rangehood body and flue covers.

Filters

Filter should be cleaned every 3-6 weeks or after approximately every 40 hours of use. Clogged and dirty filters will restrict airflow and lower your rangehoods performance.

Hand Washing

Use detergent and hot soapy water, rinse after soaking with hot water.

Dishwasher

Wash separately, the colour of the mesh filters can change after several washes, this is normal and is not a necessary indication for new replacement filters.

CONDENSATION

An induction cooktop is designed to provide rapid heating, improved thermal efficiency and greater heat consistency. For some customers with an induction cooktop, condensation can form on their rangehood filters while using their cooktop.

The induction cooktops heat source is contained in the conductive base of the pot. When compared with a gas, electric or wok burner, the heat is not isolated or contained to one area and therefore gradually rises on all sides of the pot or fry pan. This combination allows the rangehood filters to warm up slowly and eliminate the formation of condensation. For induction cooktops, the immediate and contained heat source can produce vapours rapidly. This prevents the filters from gradually warming up and increases the chance of condensation forming.

Some variables that can contribute to condensation forming on rangehoods & filters above induction cooktops are:

Location in New Zealand and variable daily temperatures
The position of your home, relative to morning and afternoon sun
The quality of cookware being used
The height of the installed rangehood
Rapid heating
Filter type and size

Condensation avoidance tips:

Turn on the rangehood 10 mins before starting to cook and turn off the rangehood 10-15mins after finishing cooking.
Do not cook at high/full power straight away, start on low or medium heat so the rangehood can warm up slightly.
Keep the filters clean and grease free.
There must be a constant flow of air into the cooking area to avoid the creation of a depression which can affect the rate of extraction.
Optimum rangehood installation height is 750mm above the cooking surface area.

Neither the rangehood nor the induction cooktop are faulty. That in some circumstances, the combination of the rangehood, the induction cooktop and the many variables within your home, can lead to condensation forming on your rangehood filters. With a gas or a standard electric cooktop, you should not have or at least have very minimal condensation.

WARRANTY

Vissari Rangehoods Onboard Series Warranty

This Warranty is provided by Rangehood Solutions Ltd – Distributor for Vissari Rangehoods.

This warranty covers the following Vissari Onboard Series Rangehoods used and installed in domestic and household applications.

Vissari Onboard Series – VISC600

Vissari Onboard Series – VISBC600

Vissari Onboard Series – VISBCS900

Vissari Onboard Series – VISPP600D

Vissari Onboard Series – VISPP900S

Vissari Onboard Series – VISC900

Vissari Onboard Series – VISBC900

Vissari Onboard Series – VISPP600S

Vissari Onboard Series – VISPP750D

Vissari Onboard Series rangehoods are covered with a 5-year warranty from the original date of purchase, this is applicable for only the original purchaser.

This warranty applies in New Zealand only.

The customer must produce the original invoice to make any warranty claim.

Warranty Exclusions

The warranty does not apply where, in Vissari Rangehoods opinion:

The product has been repaired or serviced by an unauthorised appliance service agent.

The Rangehood and was not installed in accordance with our instructions.

The Rangehood/Product was not cared for in accordance with our instructions.

The defect is caused by misuse, wear and tear, dirt, fire or accidental damage.

LED Light replacements are not covered.

Service agents call out costs, if the rangehood is found to be in normal working order.

The customer must provide the original invoice as proof of the original purchase date.

Costs incurred on installation or removal of a product, or any reinstallation or any associated costs are not covered by this warranty.

The repairs relate to the replacement of consumable parts such as fuses in plugs.

Damage or defects have not been reported within 48 hours of delivery, otherwise no claim will be recognised.

The breakdown occurs after the expiry of the warranty period.

How to make a claim

You may make a claim under this warranty by emailing us at: info@rangehoodsolutions.co.nz
Please email a copy of your original invoice as proof of purchase.



SHOWROOMS

Auckland - East Tamaki

Bay Of Plenty - Mount Maunganui

Waikato - Te Rapa

P 0800 RANGEHOODS / E info@rangehoodsolutions.co.nz / www.vissari.co.nz